



Wuxi Comput Electronics Co.,Ltd

Mail: Sales@compul.cn Web: www.compul.cn

Tel: 86 510 87359088 Fax: 86 510 87359268

Package Dimensions

CPS18011GH

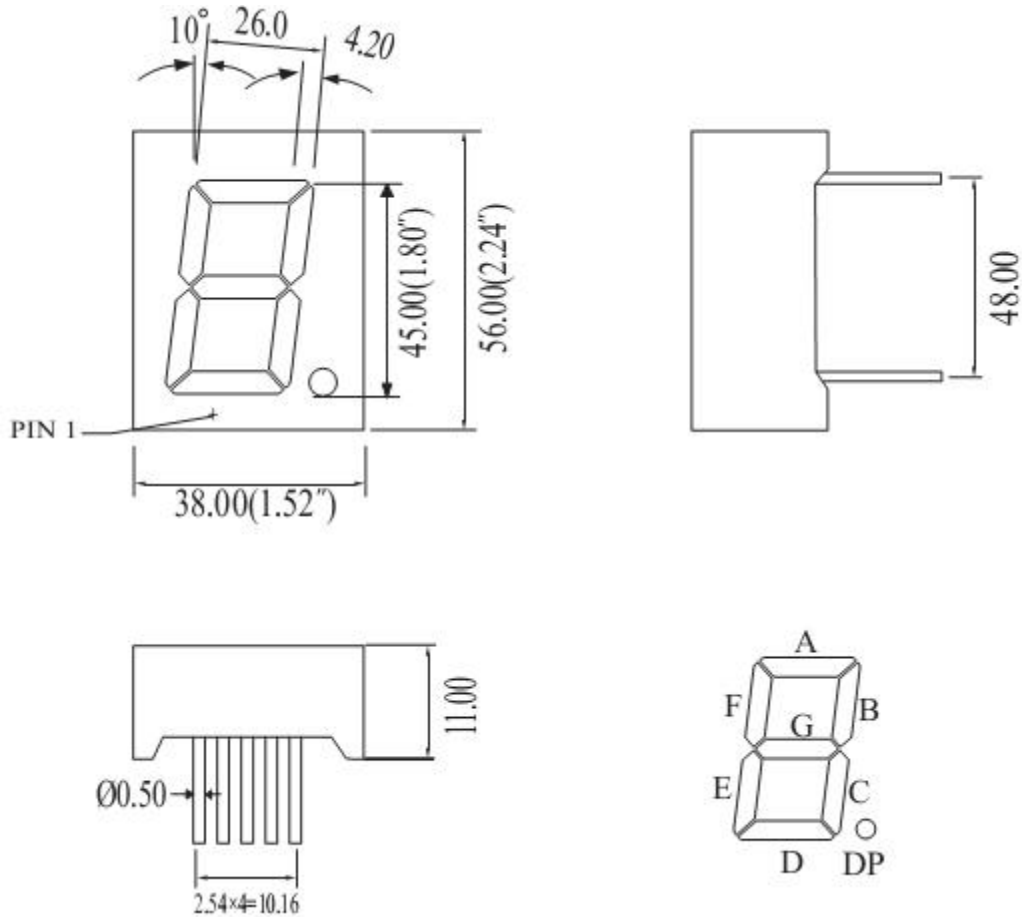

UNIT: MM(INCH) TOLERANCE: $\pm 0.25(0.01)$ "

Internal Circuit Diagram

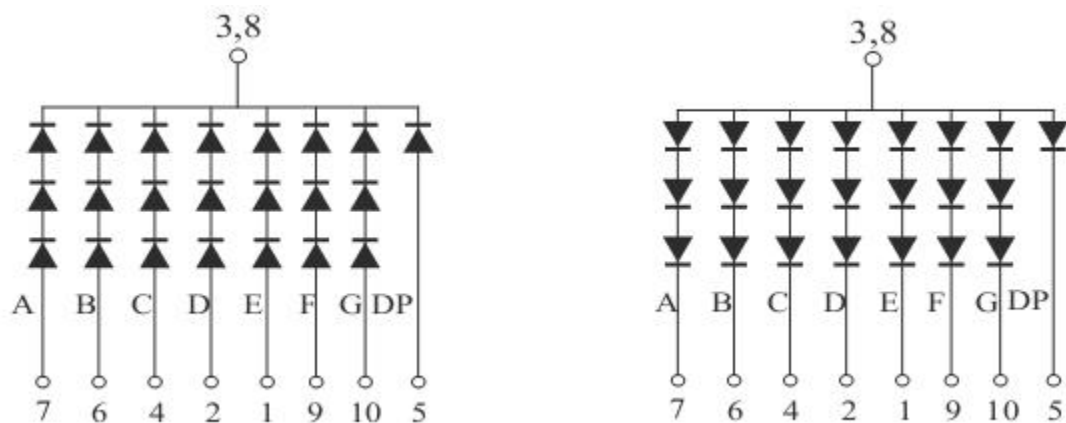

18011G

18011H

Single Digital Displays Series